



EFFICIENT, INNOVATIVE LUBRICANT AND GREASE PRODUCTION

Prepared for:
CIS FUELS AND LUBRICANTS CONFERENCE

Heino Decker / Moscow, 22 May 2013

The Lube Oil Market

The market development is of course not uniform and is marked by the following features:

- It is a market with hard competition.
- It is a growth market.
- It is a developed market.
- Success strategies in these markets are:
 - lowest production cost
 - highest practicable product services and quality
- It is a market that is partly overheated.
- And, finally, it is also a market of changes.

The Lube Oil Market

Lubricants Product Variety Raw Material Diversity

USE OF BASE OIL

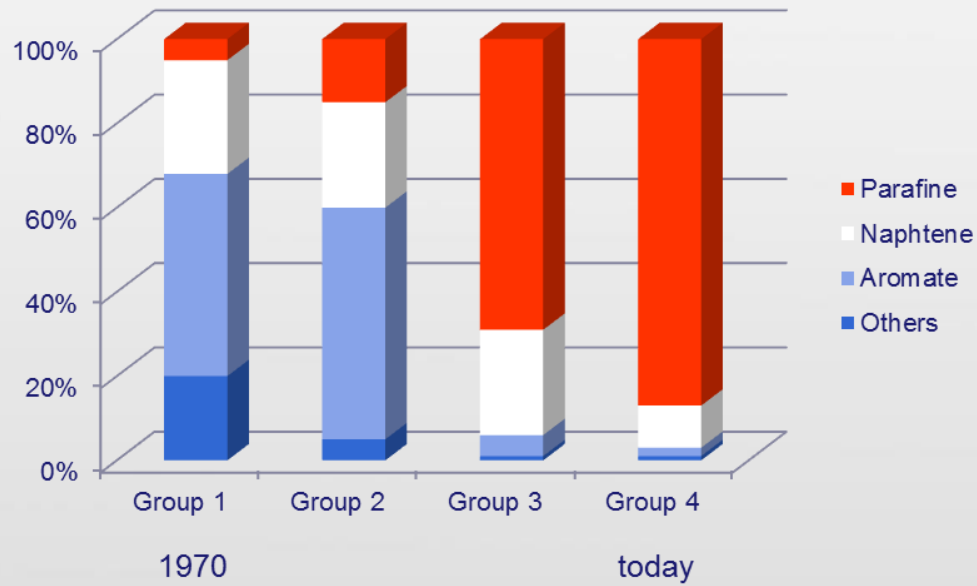

USE OF ADDITIVES

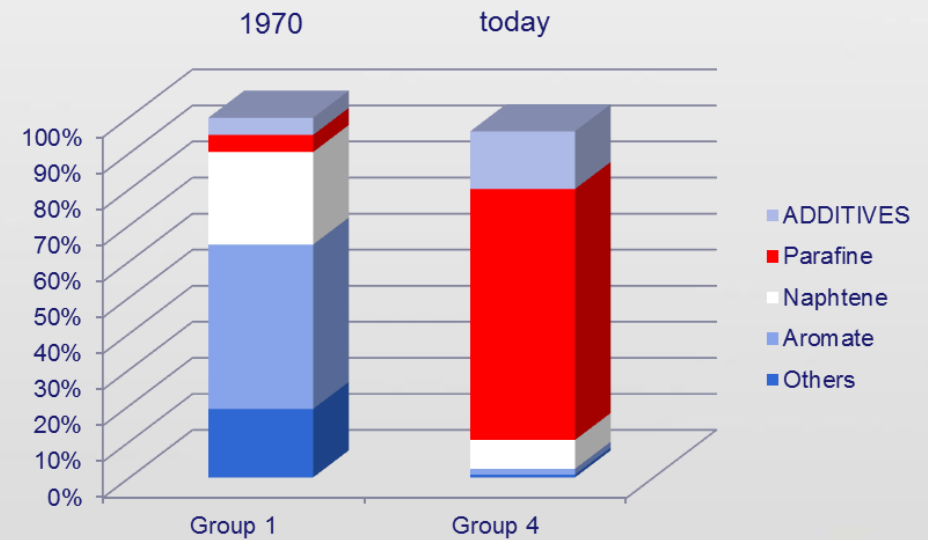

The Lube Oil Blending Plant is Part of the Supply Chain!

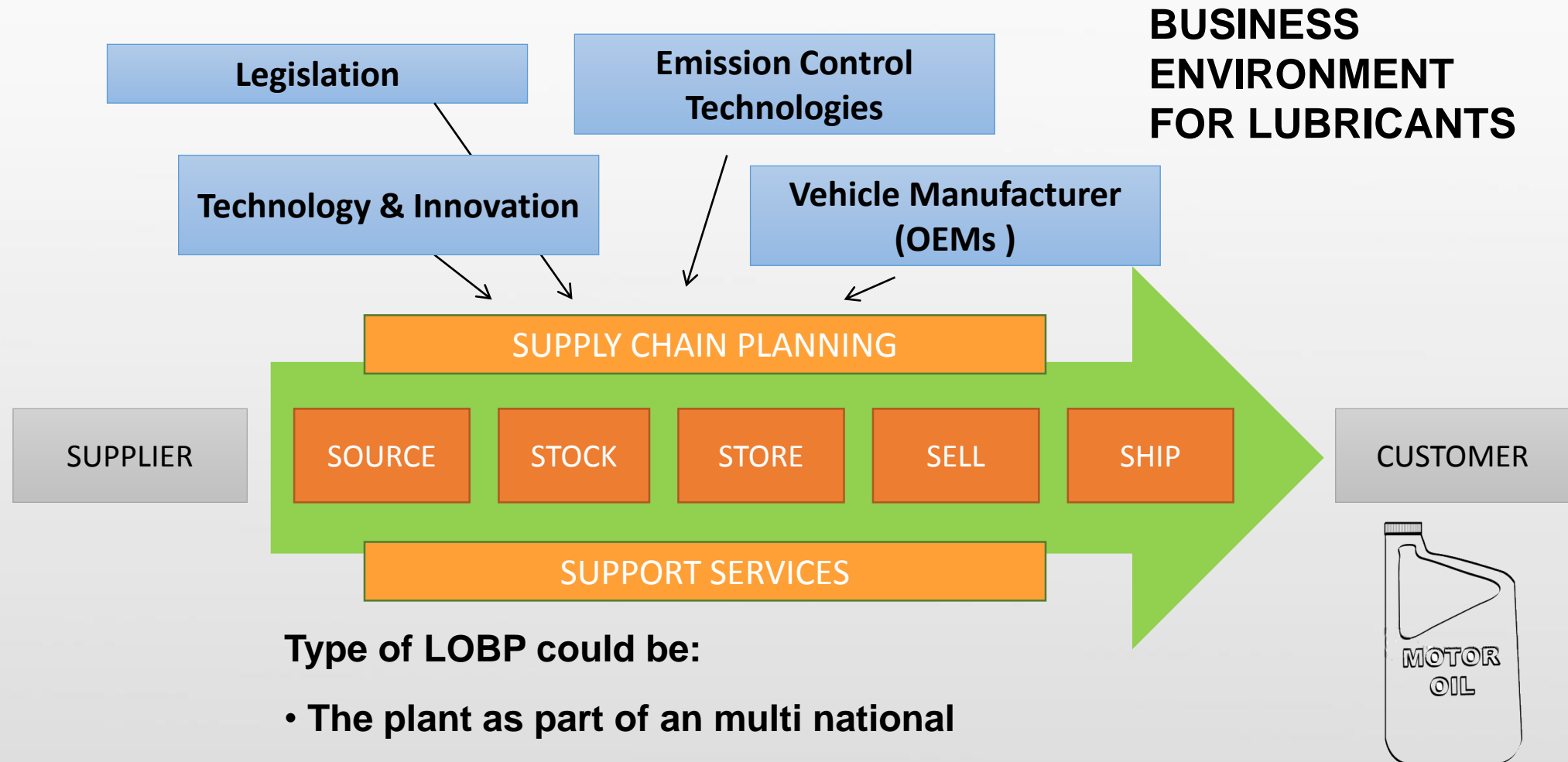

Type of LOBP could be:

- The plant as part of an multi national
- Contract blending without own brand name
- Independent manufactures with own brand

Typical Cost Structure of a Lube Oil Blending Plant

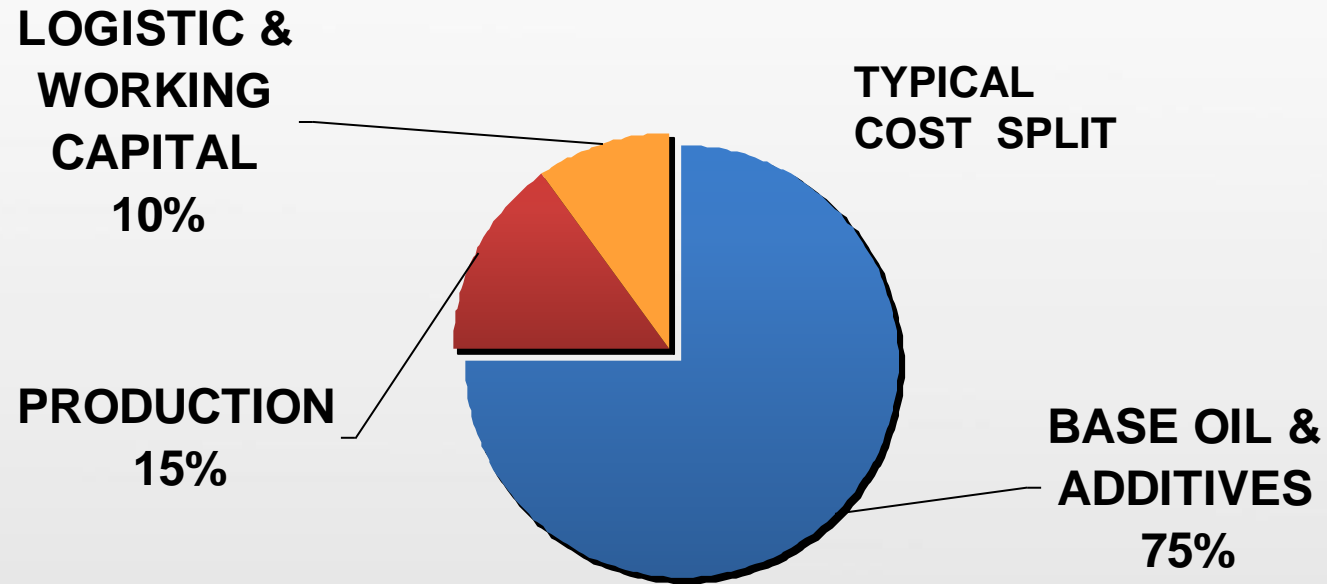

Savings Potential

- Base oil & additives > reduce giveaways by precise dosing
- Production > reducing slop oil and rework
- Working capital > reducing energy, clever investments; automation

A Make: Lubricants Blending and Packaging

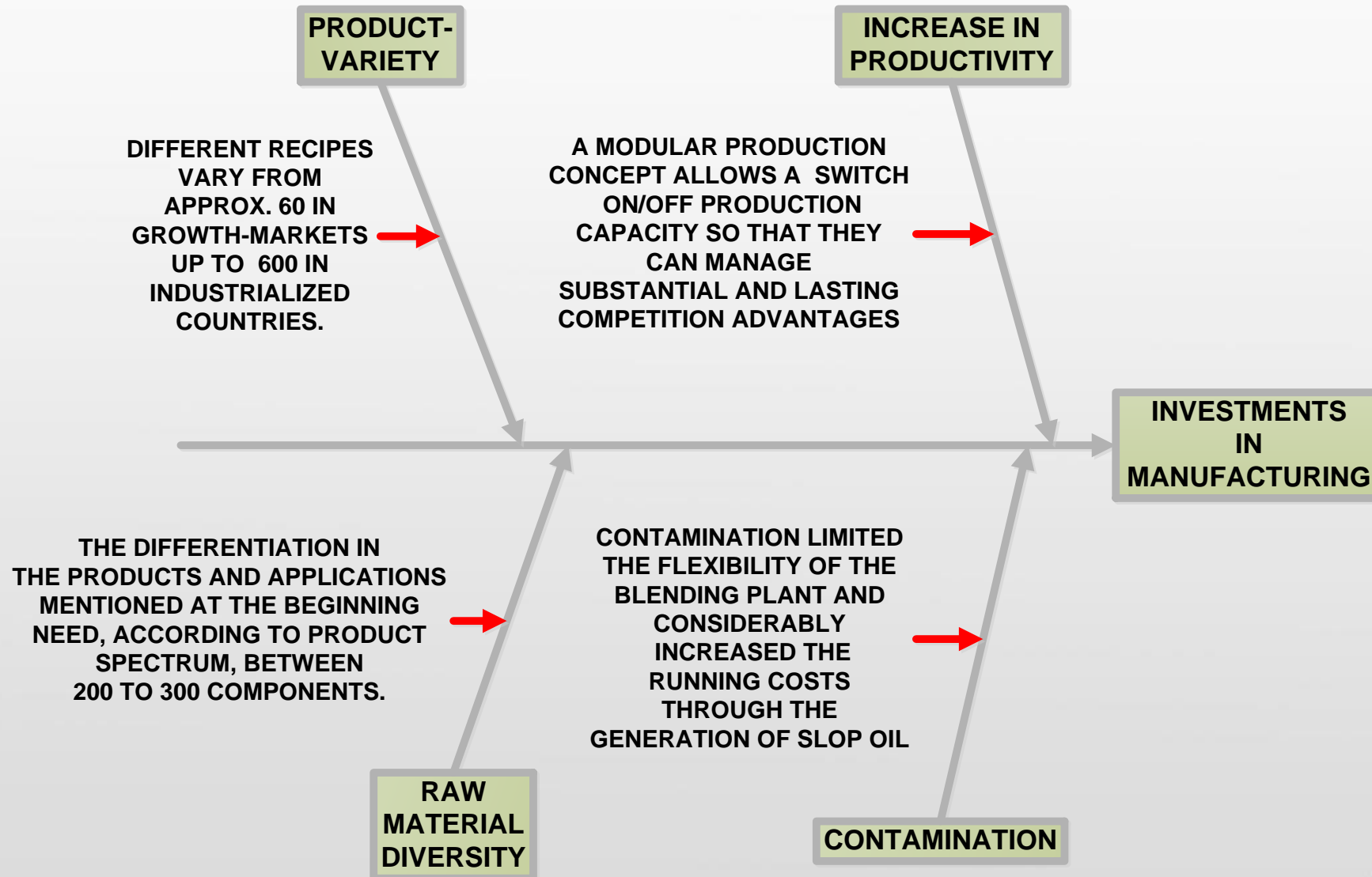

Concept of Lube Oil Blending Plant

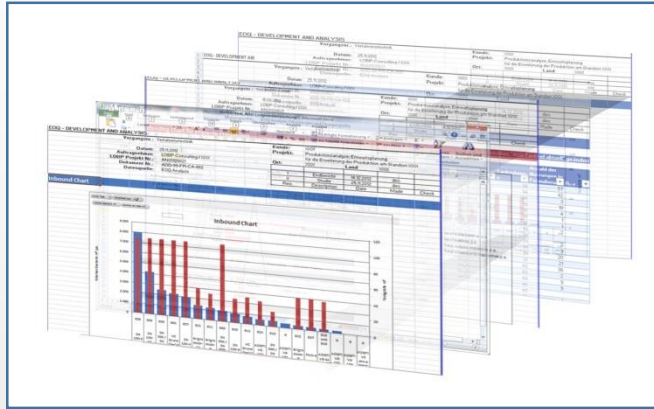

Tools and Systems

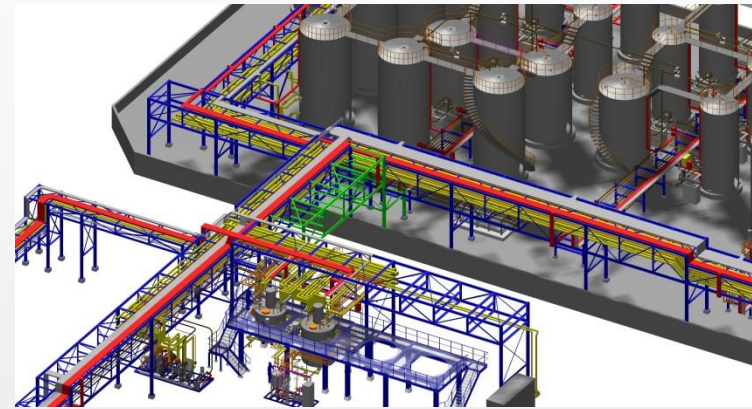

3D-Planning

Hard Facts
Changeability
Technology
Productivity
Energy

Soft Facts
Ecology
Communication
Aesthetics
Identity



Simulation / Lube Oil Blending Plant Model

From Concept to Completion

Accuracy and Precision of each Component

1. Accuracy and Precision

Target of each component is $\pm 1\%$ to pass the tests in the lab at the first time

2. Batches Changeability

is typical in the range of 1 to 100 or more

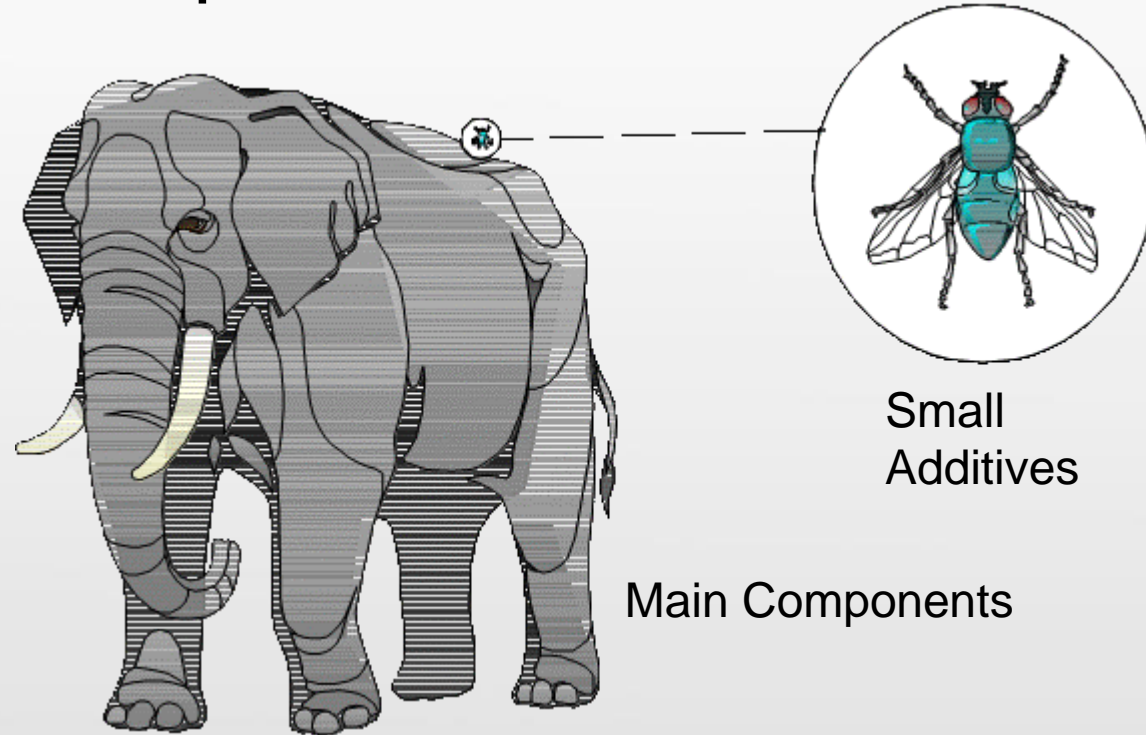

The process using different dosing technologies like inline blender, batch blender, and the like will reduce the potential source of error and thus reduce the risk of out-of-specification results.

From Concept to Completion

Planned Production & Typical Selection of Blenders

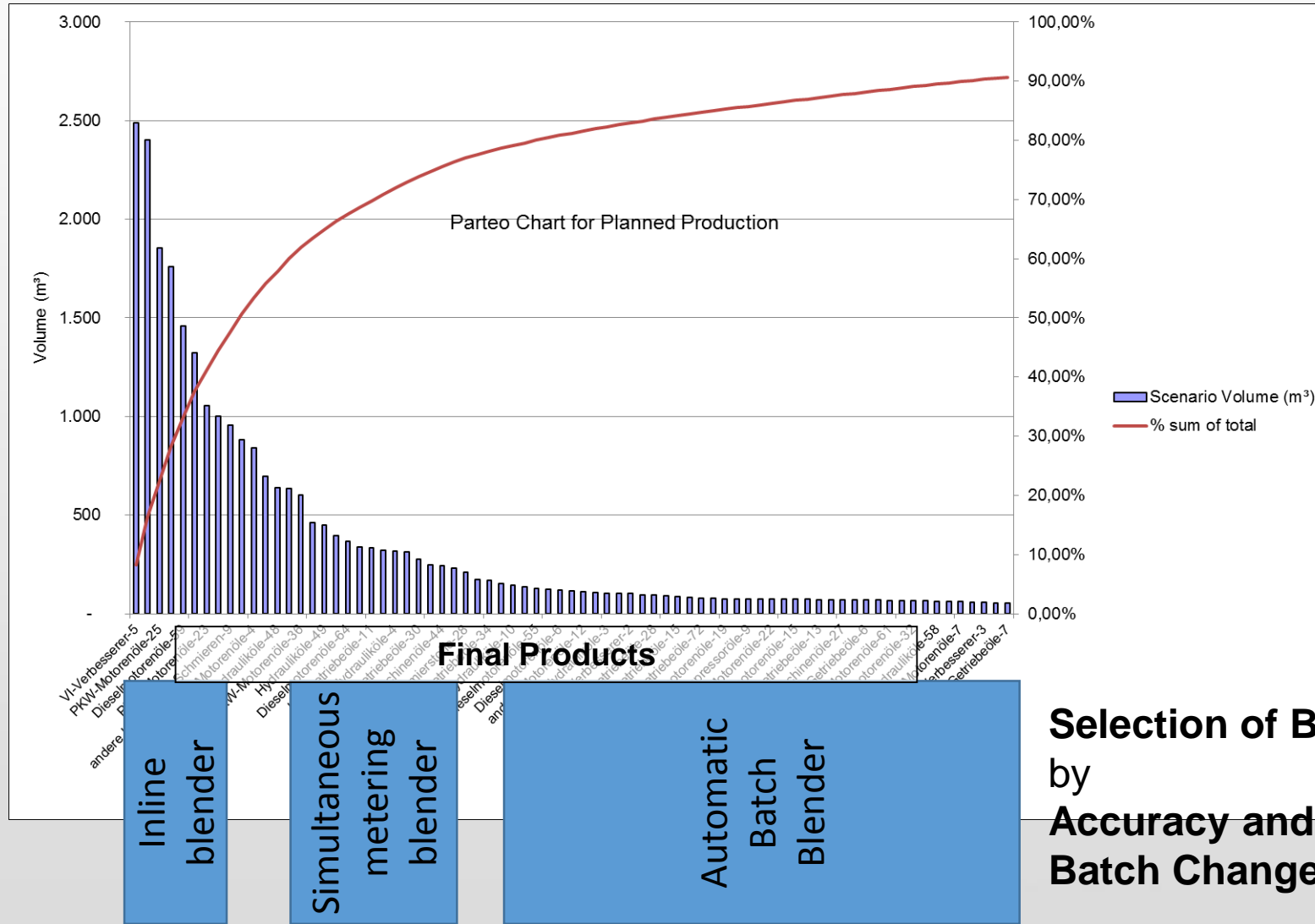

From Concept to Completion

Typical Blending System

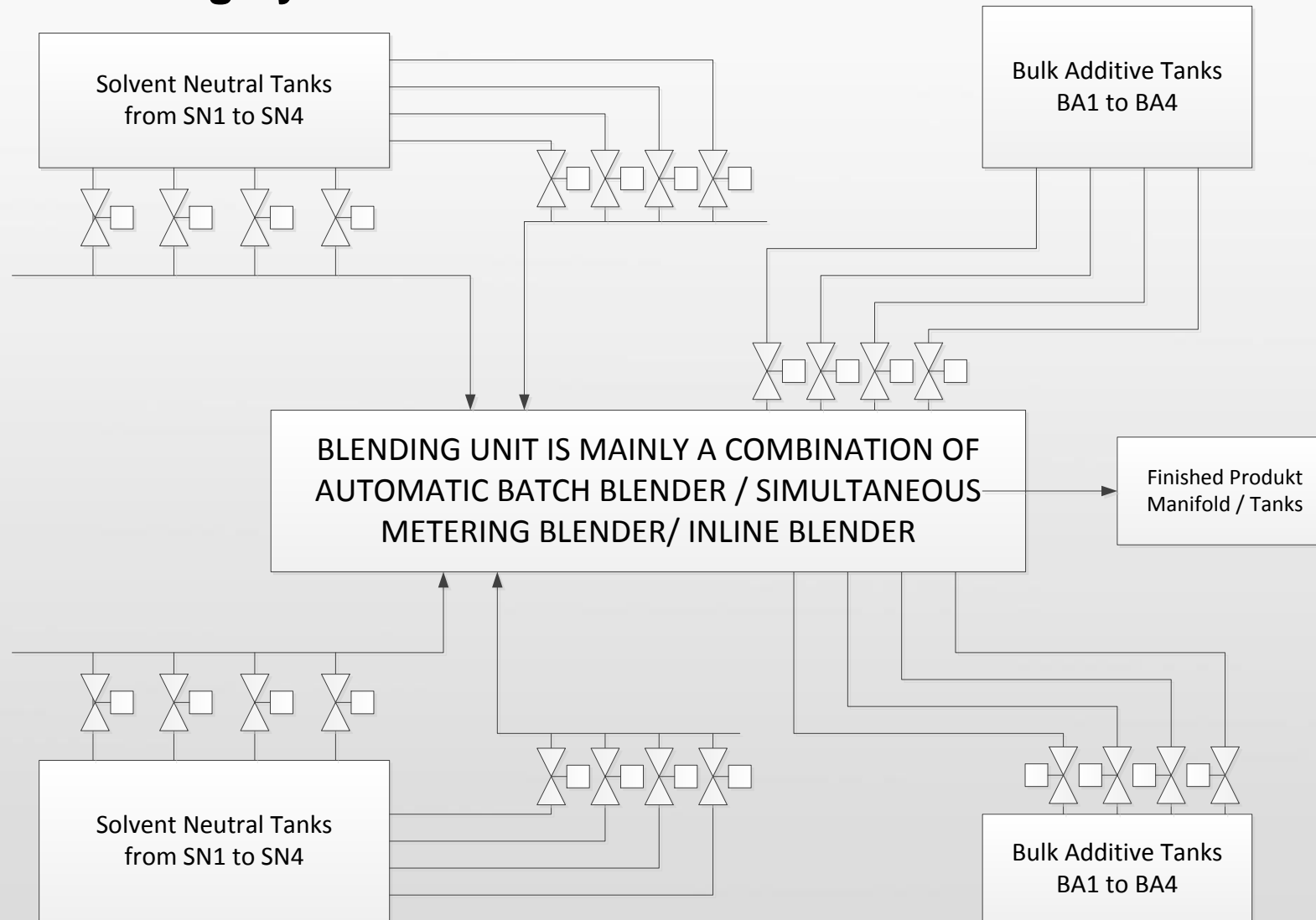

From Concept to Completion

Automatic Batch Blender

Example of a
Load Cell-mounted
Blending Unit

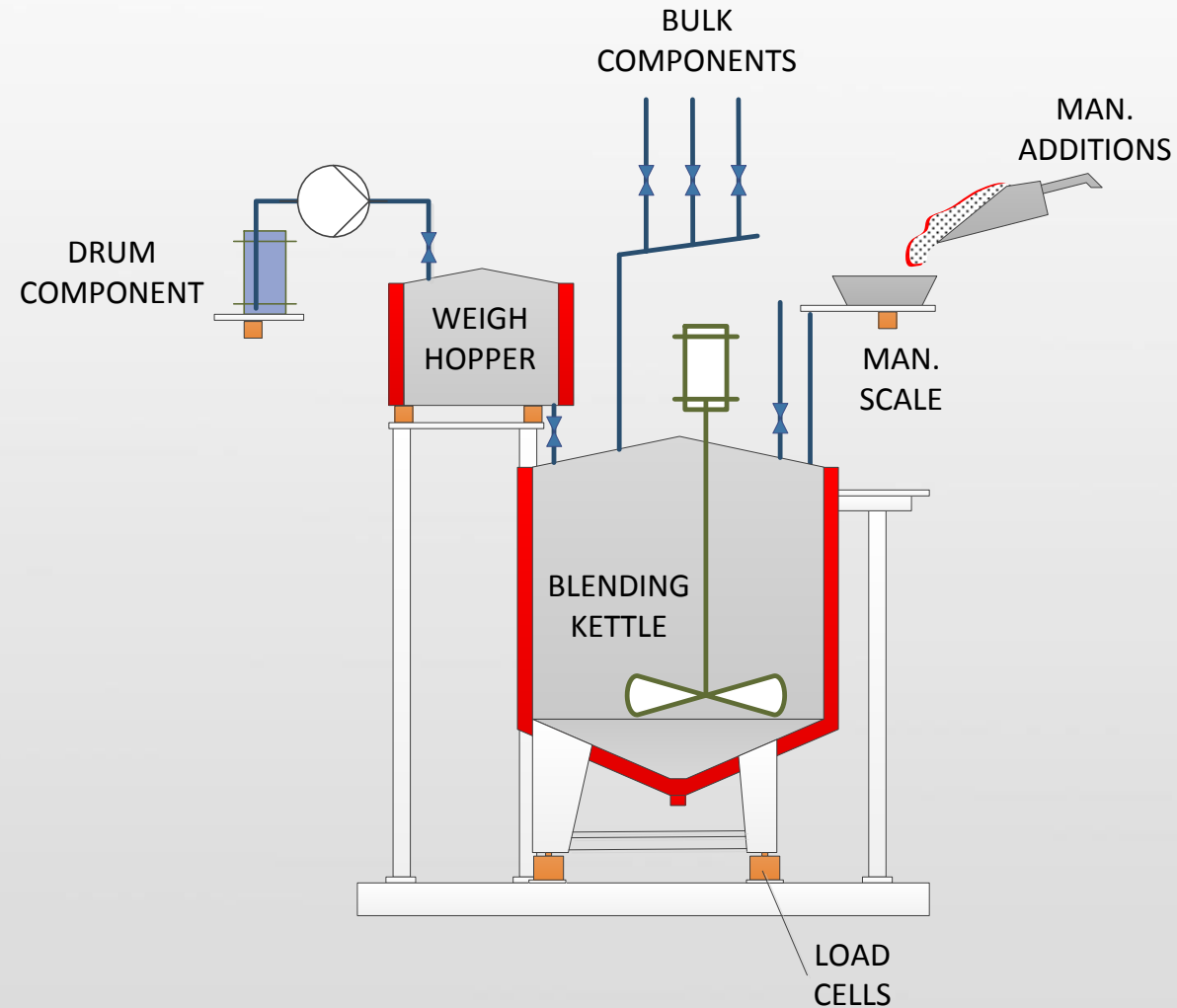

From Concept to Completion

Metering Blender as Inline or Simultaneous Operation

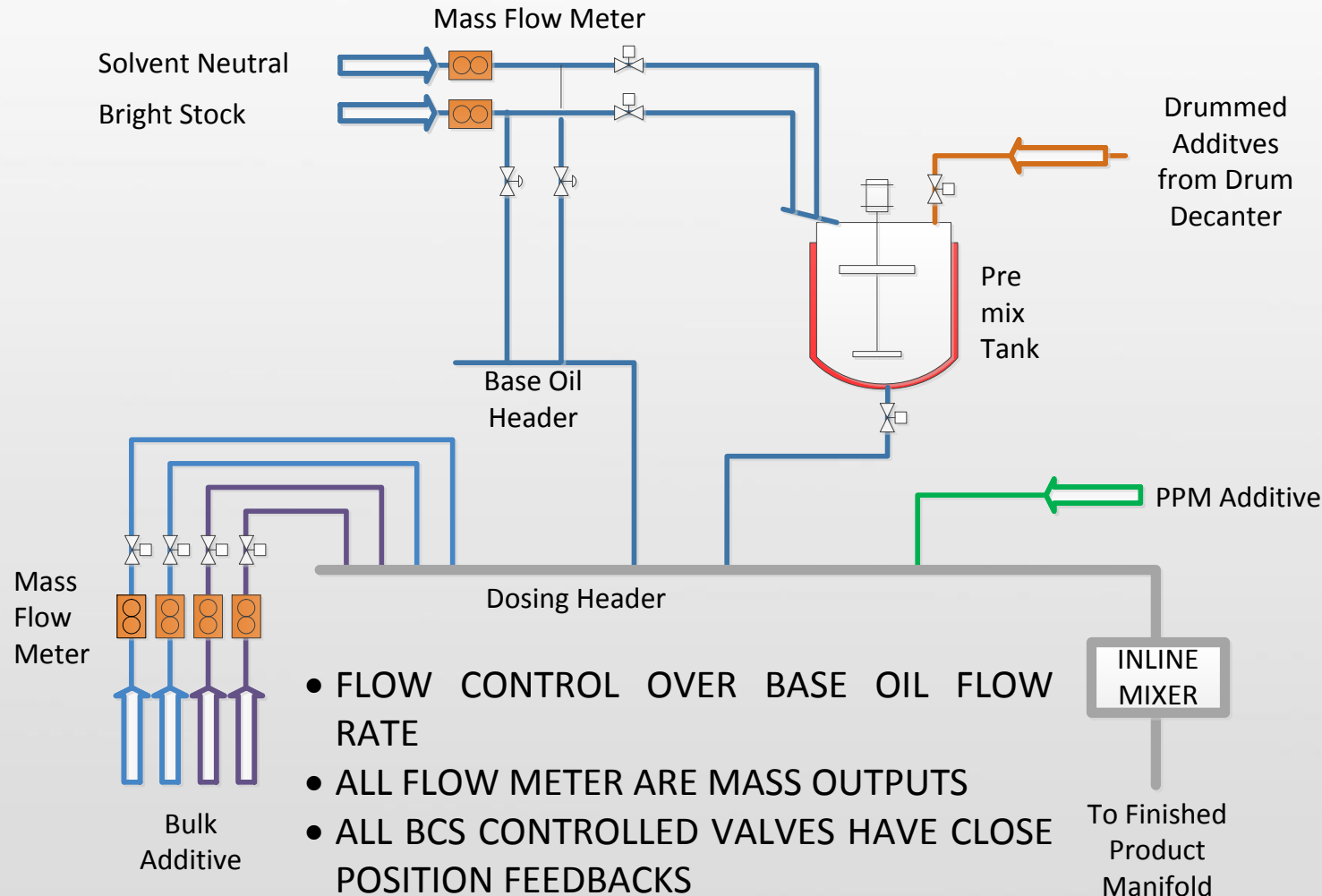

From Concept to Completion

Metering Blender as Inline or Simultaneous Operation

Simultaneous Metering Blender (SMB):

- Sequence Operation
- Homogenization mainly in the Finished Product Tank TANK

Inline Blender (ILB):

- Proportional Operation
- Homogenization mainly in the Blending Header

Typical Motor Oil

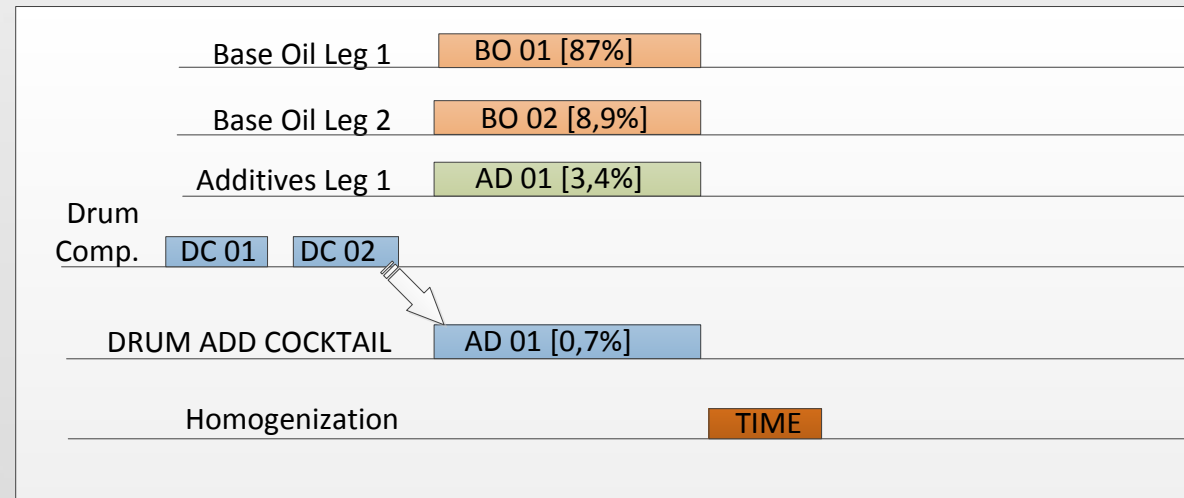
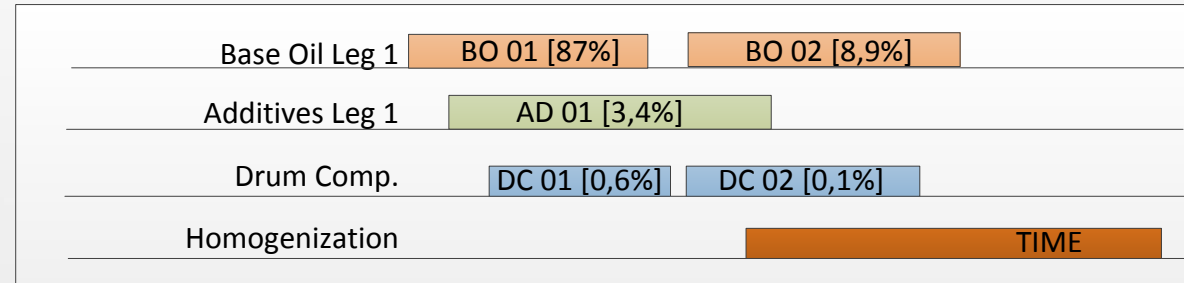

From Concept to Completion

Typical Piggable Product Line

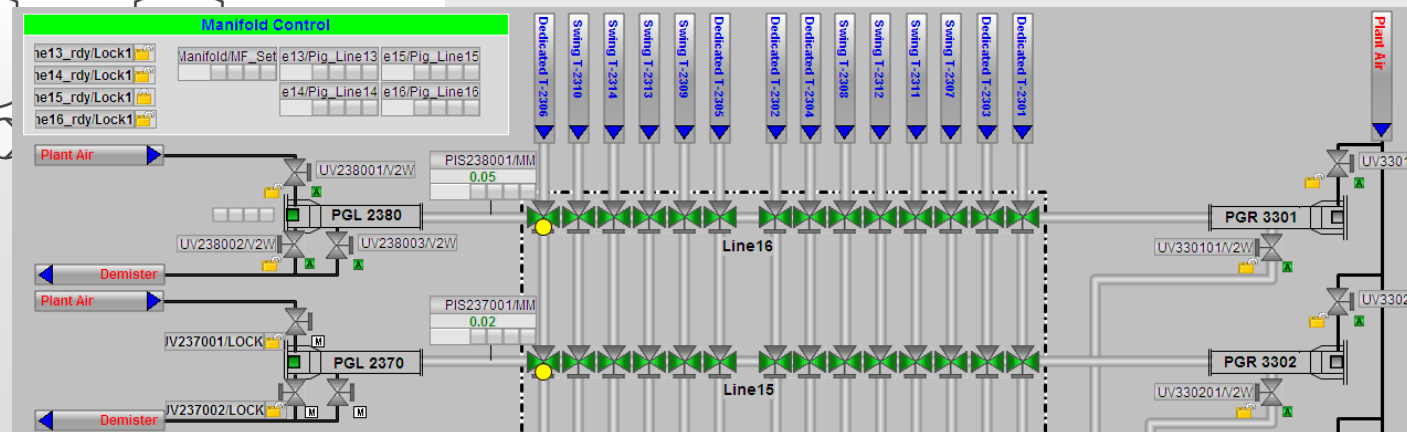
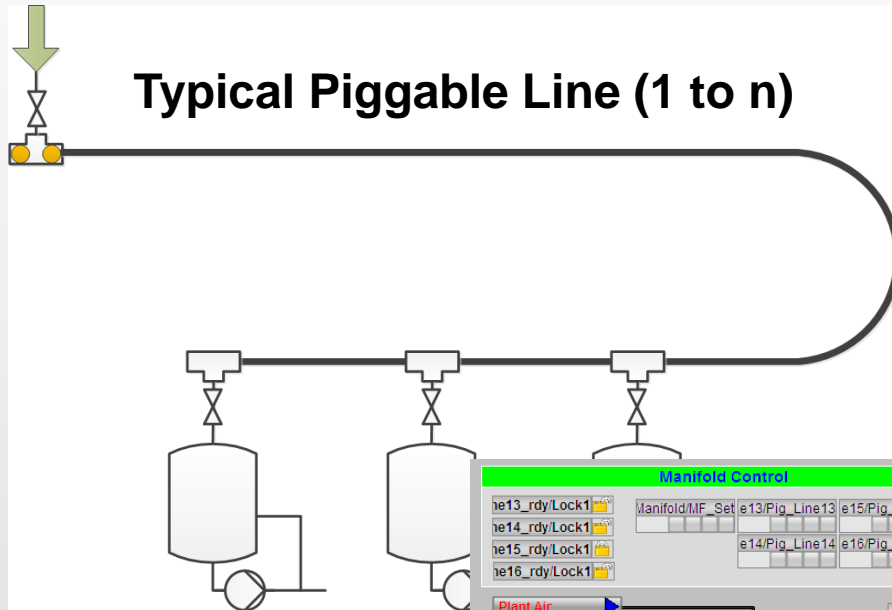

Manifold Operation (n to n)

From Concept to Completion

Automation Functions

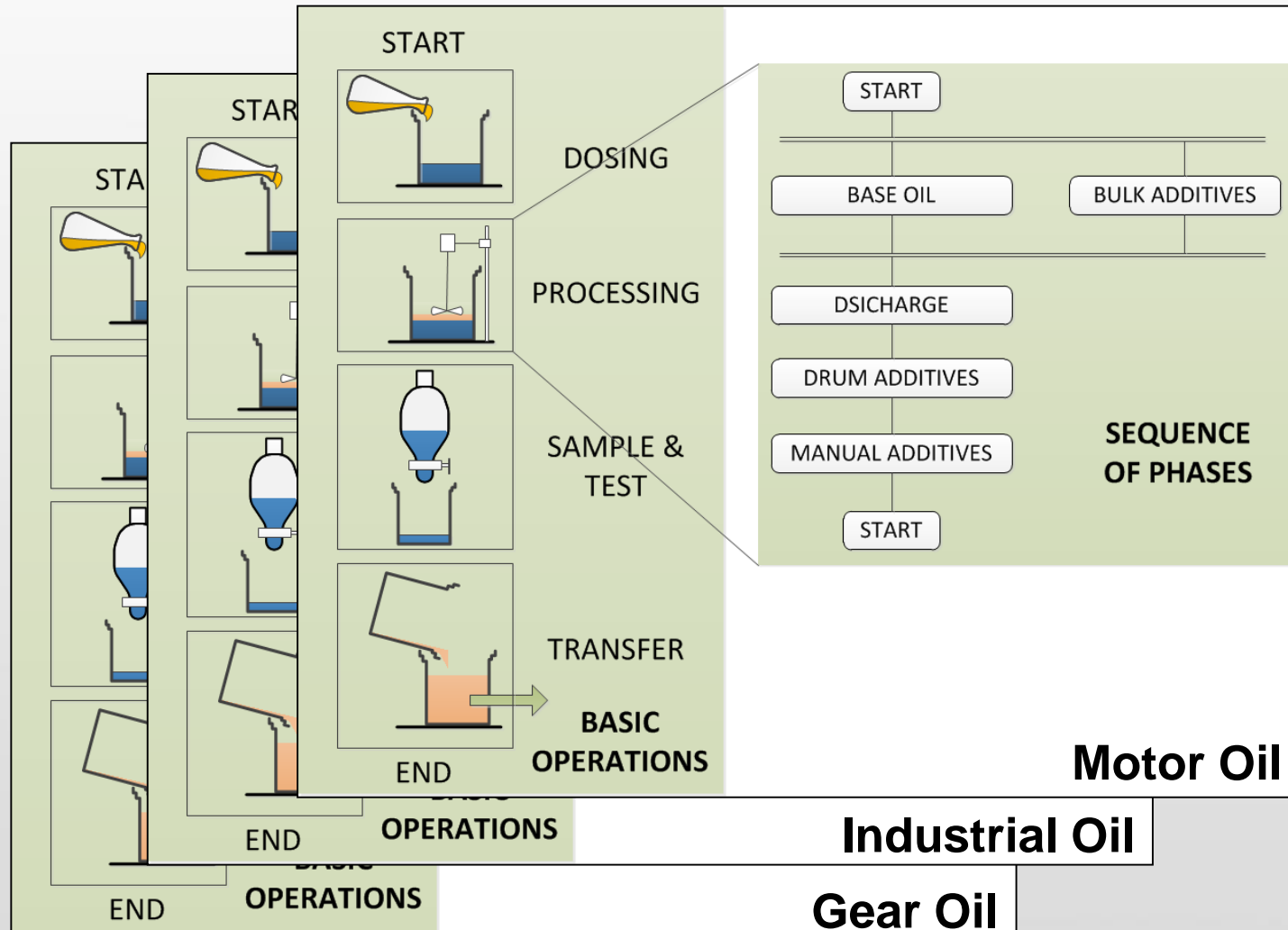

The lubricant plants are mostly designed as **'multiple product / multiple line plants'**. High flexibility in the production can only be reached by **Automation**.

From Concept to Completion

When handling the complexity in the filling area, some principles should be taken into account.

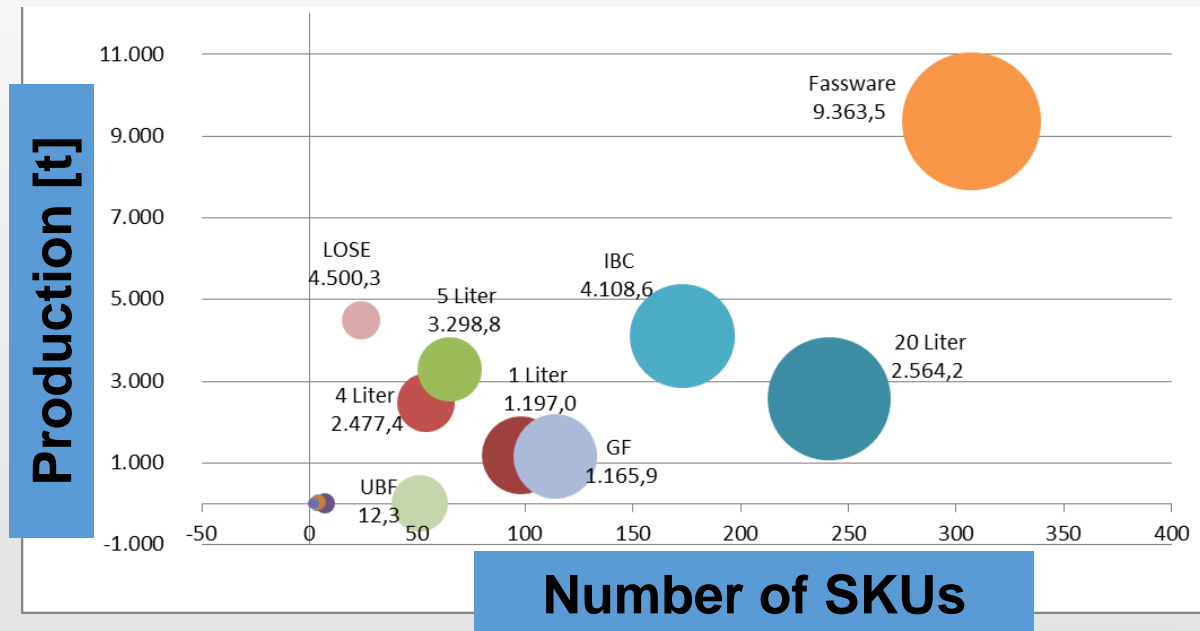

Pareto Principle (80:20)

This method is based on the premise that 80% of the production area associated with the top 20% packaging handled by the filling area (fast mover).

Product Grouping

The Stockkeeping Units (SKUs) must be classified into product groups which all have a similar packaging type.

These groups can then be prioritized based on packaging complexity and minimum change over times for the filling machine.

From Concept to Completion

Filling Layout & Warehousing

The Filling & Warehouse Management should make every effort to meet the continuing demands and guarantee a well-organized filling & warehousing to achieve short delivery times of lubricants.



Future Aspects of Production

Development in Blending Technology

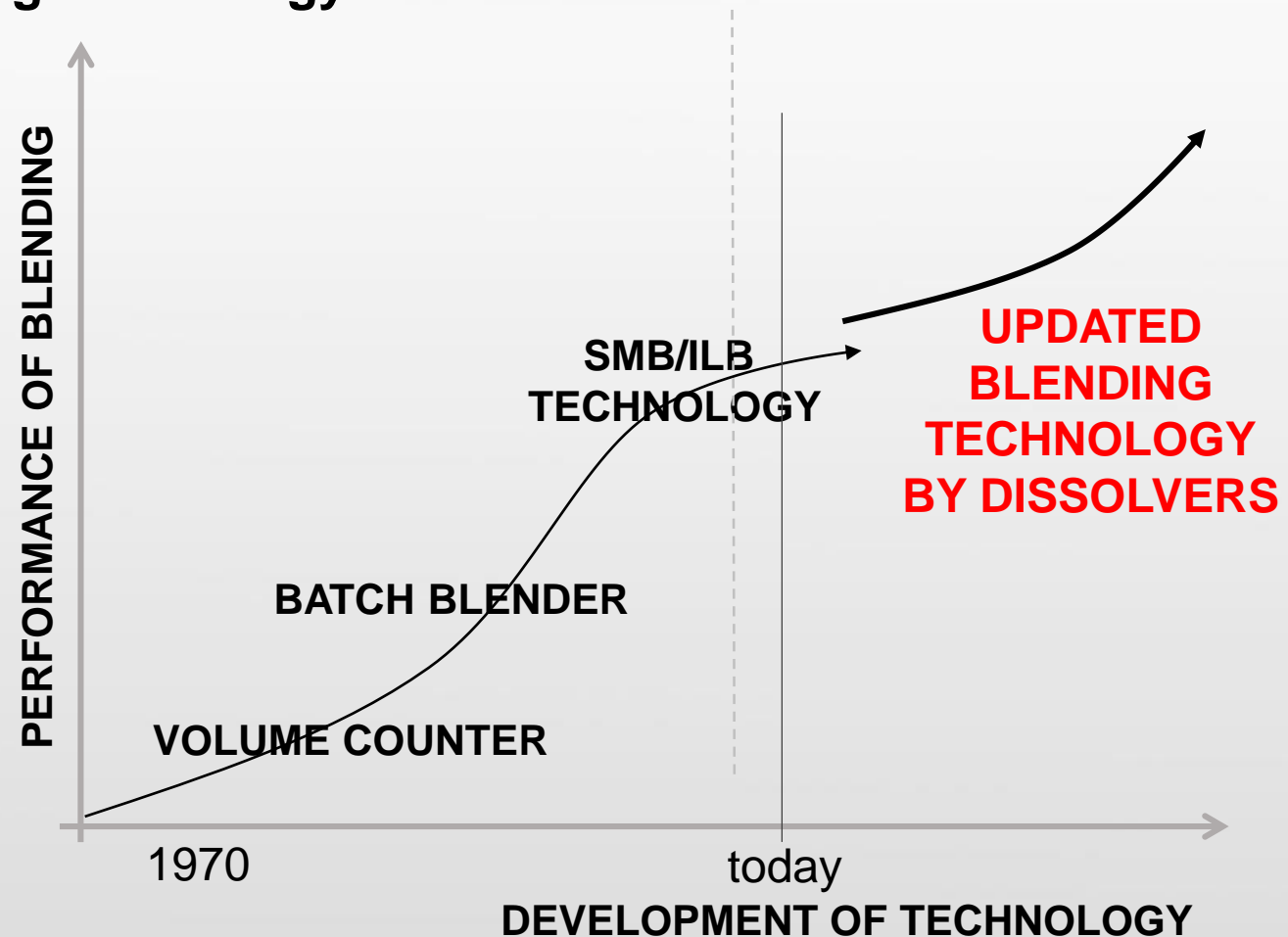
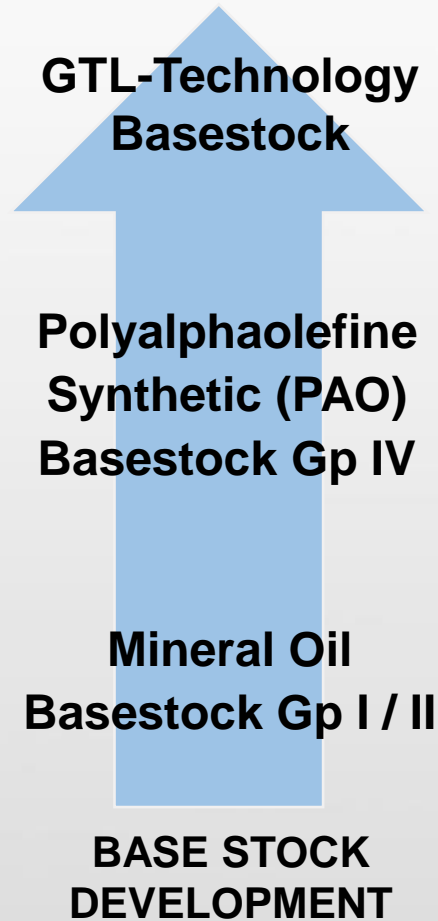

**Advanced lubricants production updates to meet
the stringent requirements of the modern formulation of lubricates.**

Future Aspects of Production

Development in Grease Production Technology

Main Types of Grease Manufacturing Processes available:

- A. Conventional atmospheric process
- B. Continuous grease process
- C. Pressure saponification process
- D. Single kettle process

In my opinion the pressure saponification process will be suitable for a wide range of different greases.

- Medium investment costs
- Very short cooking time, so short effective average batchtime, so high output
- Medium energy costs
- Very flexible in all kind of raw materials processing
- Economical percentage of soap ingredients

Future Aspects of Production

Development in Grease Production Technology

Process in Combination with Formulas

Producing high-quality greases for a competitive price is not only a question of selecting the right process, but also of well-balanced specifications.

- Thermal fluid heating systems up to 280°C
- Cooling system
- Pressure up to 8bar
- Anchor stirrer frame and product loaded scrapers
- Automation

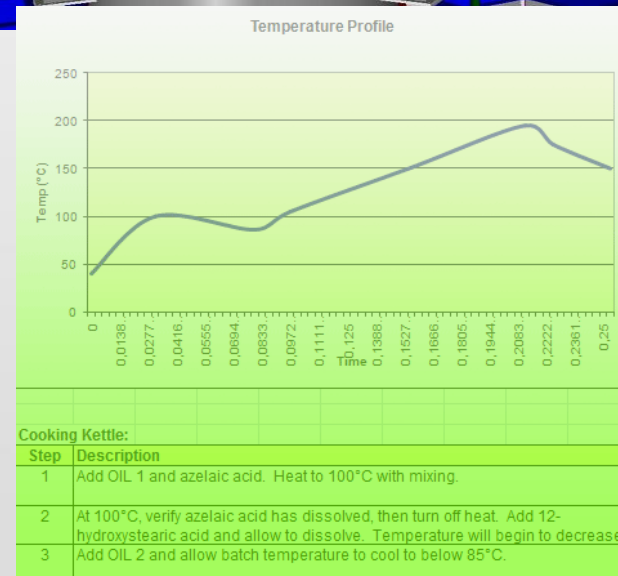
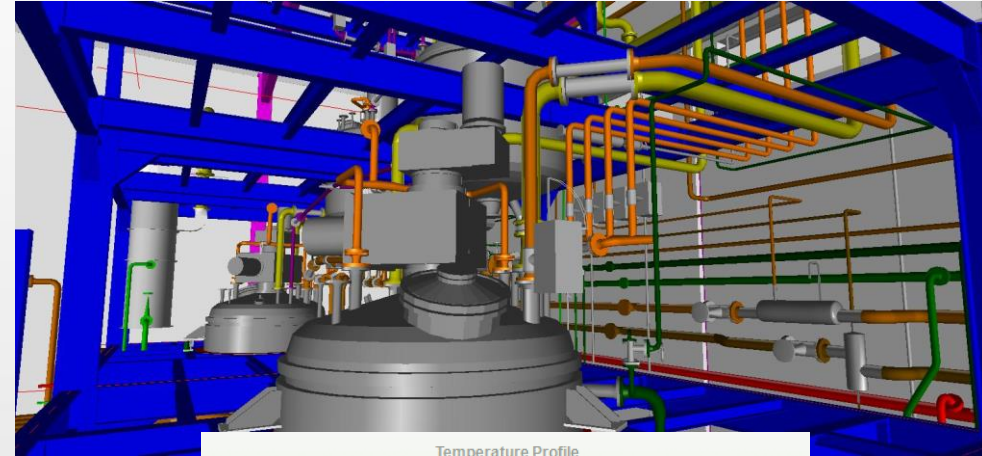

Future Aspects of Production

Summary

Production Plant Overview

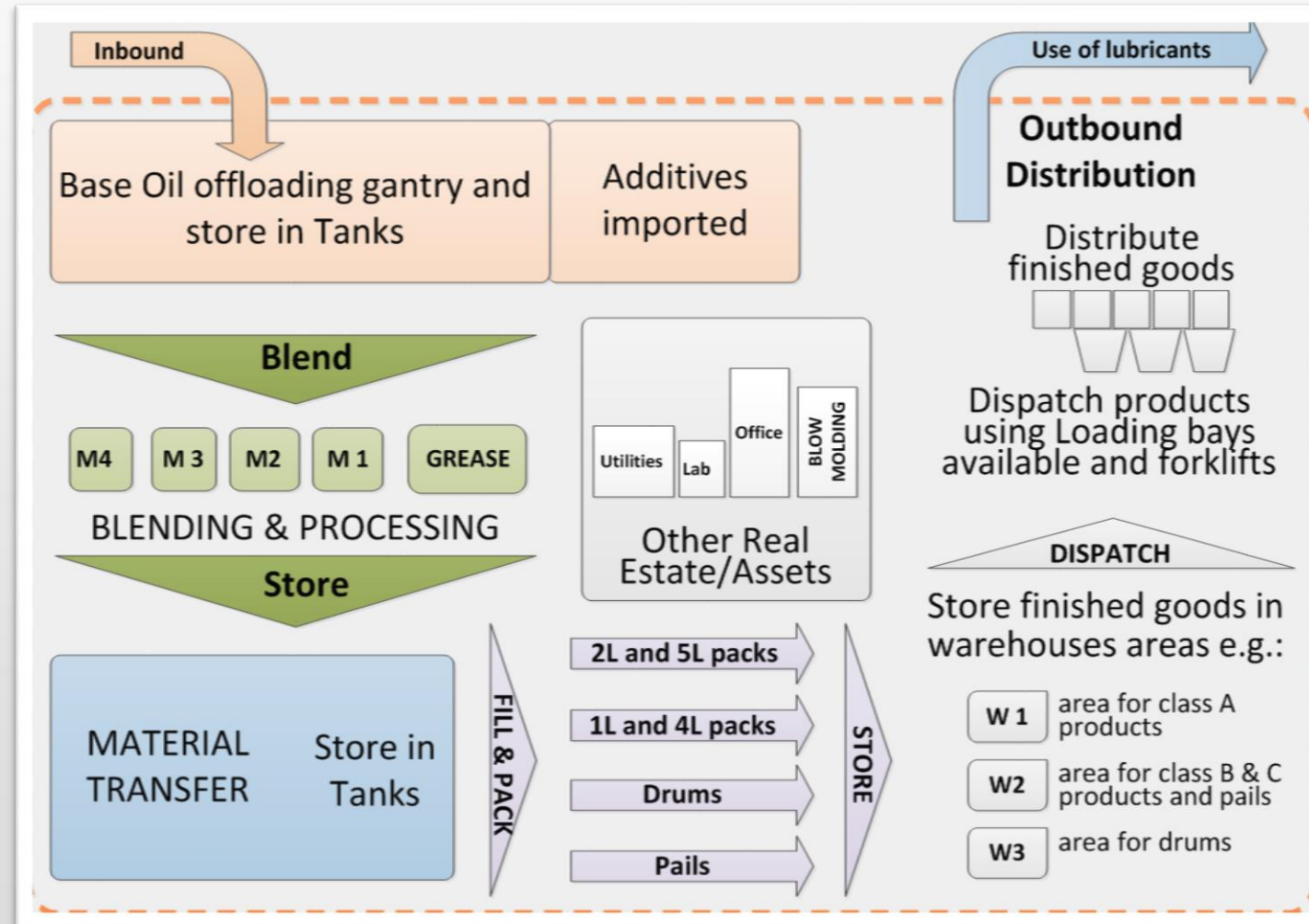

Contact information

- info@lobp.com

LOBP Consulting GmbH

Hagener Allee 63a
D-22926 Ahrensburg
Germany



www.lobp-consulting.com

Reproduction of any material whether by photocopying or storing in any medium by electronic means or otherwise is prohibited without prior written consent of LOBP-Consulting.
© Copyright LOBP-Consulting GmbH 2013.
All rights reserved
See the legal disclaimer notice on www.LOBP-Consulting.com